

PCE



Connection
to the future

POWER-BOX
I M S T
POWER-BOX
POWER-BOX
POWER-BOX
POWER-BOX
POWER-BOX
POWER-BOX
POWER-BOX
POWER-BOX
POWER-BOX





IMST

POWER-BOX

MOBILE VERSION

FEATURES

- handy, robust distribution box made of shock-resistant polyamide
- for distributing electricity to powered equipment or lighting systems on building sites
- ideal for craft businesses, the building trades, farmers, etc.
- maximum rated current of 32A 5p 400V
- up to 8 sockets
- window for up to 8 modules
- IP44, ready wired for connection
- also available in red

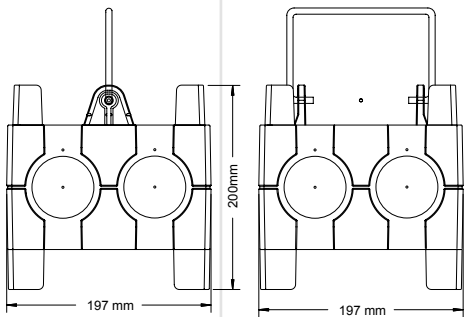

9030...

MOBILE POWER-BOX

- **WxHxD = 197x200x197mm**
- **with carrying-handle made of high-grade steel**
- stackable, with take-up device for the connecting cable



- the mobile version has a take-up device for the connecting cable



- the mobile version can be stacked
- space-saving storage



NON-FUSED

- **9030010**
- 2 CEE-sockets 16A 5p 400V
- 4 sockets (DIN 49440) 16A 250V
- CEE-plug 16A 5p 400V



NON-FUSED

- **9030020**
- 2 CEE-sockets 16A 5p 400V
- 5 sockets (DIN 49440) 16A 250V
- 2m cable H07RN-F 5G2,5 with CEE-plug 16A 5p 400V

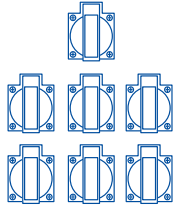

NON-FUSED

- **9030030**
- 7 sockets (DIN 49440) 16A 250V
- 2m cable H07RN-F 3G2,5 with rubber-plug 16A 250V

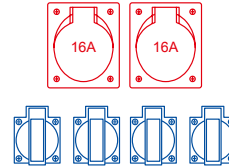

WINDOW for 6 MODULES

- **9030014**
- 2 CEE-sockets 16A 5p 400V
- 4 sockets (DIN 49440) 16A 250V
- 1 RCD 40A/4/0,03A - for all outlets
- CEE-plug 16A 5p 400V



WINDOW for 6 MODULES

- **9030206**
- 2 CEE-sockets 16A 5p 400V
- 4 sockets (DIN 49440) 16A 250V
- 2 MCBs 16A 1p-C
- 1 RCD 40A/4/0,03A - for all outlets
- CEE-plug 16A 5p 400V

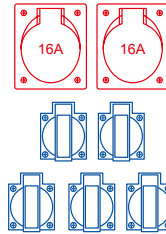

WINDOW for 6 MODULES

- **9030004**
- 2 CEE-sockets 16A 5p 400V
- 5 sockets (DIN 49440) 16A 250V
- 1 RCD 40A/4/0,03A - for all outlets
- 2m cable H07RN-F 5G2,5 with CEE-plug 16A 5p 400V



WINDOW for 6 MODULES

- **9030204**
- 2 CEE-sockets 16A 5p 400V
- 5 sockets (DIN 49440) 16A 250V
- 2 MCBs 16A 1p-C
- 1 RCD 40A/4/0,03A - for all outlets
- 2m cable H07RN-F 5G2,5 with CEE-plug 16A 5p 400V

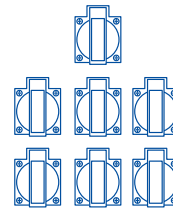

WINDOW for 6 MODULES

- **9030040**
- 7 sockets (DIN 49440) 16A 250V
- 1 RCD 40A/4/0,03A - for all outlets
- 2m cable H07RN-F 3G2,5 with rubber-plug 16A 250V

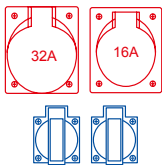

WINDOW for 8 MODULES

- **9030109**
- 1 CEE-socket 32A 5p 400V
- 1 CEE-socket 16A 5p 400V
- 2 sockets (DIN 49440) 16A 250V
- 1 MCB 16A 3p-C
- 1 MCB 16A 1p-C
- 1 RCD 40A/4/0,03A - for all outlets
- CEE-plug 32A 5p 400V

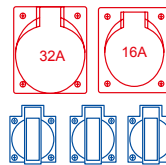

WINDOW for 8 MODULES

- **9030117**
- 1 CEE-socket 32A 5p 400V
- 1 CEE-socket 16A 5p 400V
- 3 sockets (DIN 49440) 16A 250V
- 1 MCB 16A 3p-C
- 1 MCB 16A 1p-C
- 1 RCD 40A/4/0,03A - for all outlets
- 2m cable H07RN-F 5G4 with CEE-plug 32A 5p 400V



WINDOW for 8 MODULES

- **9030119**
- 2 CEE-sockets 16A 5p 400V
- 2 sockets (DIN 49440) 16A 250V
- 2 MCBs 16A 3p-C
- 2 MCBs 16A 1p-C
- CEE-plug 32A 5p 400V

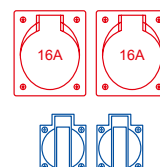
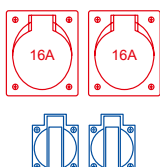

WINDOW for 8 MODULES

- **9030129**
- 2 CEE-sockets 16A 5p 400V
- 2 sockets (DIN 49440) 16A 250V
- 2 MCBs 16A 3p-C
- 2 MCBs 16A 1p-C
- 2m cable H07RN-F 5G4 with CEE-plug 32A 5p 400V

IMST

POWER-BOX

SUSPENDED VERSION

FEATURES

- robust distribution box made of shock-resistant polyamide
- for distributing electricity to powered equipment or lighting systems on building sites
- ideal for craft businesses, the building trades, farmers, etc.
- maximum rated current of 32A 5p 400V
- up to 8 sockets
- window for up to 8 modules
- IP44, ready wired for connection



- version: electricity

9031

SUSPENDED VERSION

- **WxHxD = 197x197x120mm**
- **with hangers made of high-grade steel**
- suitable for combinations of electricity and air



- version: electricity / air

WINDOW for 6 MODULES

- 9031598

- **Entry:**
1 M25-cable gland on top
- **Outlet:**
6 sockets (DIN 49440) 16A 250V
2 MCBs 16A 1p-C
1 RCD 40A/4/0,03A

1 terminal block 5p 10mm²

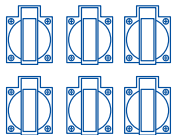

WINDOW for 8 MODULES

- 9031022

- **Entry:**
1 M25-cable gland on top
1 quick-lock air coupling
2-fold 1/2"

- **Outlet:**
1 CEE-socket 16A 5p 400V
4 sockets (DIN49440) 16A 250V
4 MCBs 16A 1p-C
1 RCD 40A/4/0,03A - for all outlets
- 1 compressing air tube size 1/2"
- 1 terminal block 5p 10mm²

9032

SUSPENDED VERSION

- **WxHxD = 197x120x197mm**
- **with 4 ring-bolts**
- non-fused

NON-FUSED

- 9032009

- **Entry:**
1 M25-cable gland on top
- **Outlet:**
8 sockets (DIN 49440) 16A 250V
1 terminal block 5p 10mm²

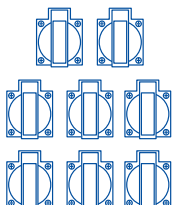

IMST

POWER-BOX

VARIATIONS

QUALITY MANAGEMENT

- for maximum customer satisfaction and top performance (ISO 9001 Certification)

SPEED

- short delivery times due to flexible manufacturing



CUSTOMER-ORIENTED

- you choose the features
- special versions in accordance with your individual wishes

FEATURES

- the housing is calculated and tested for the highest mechanical loads
- all models are available in splash-proof design
- easy installation through optimum access to terminals



PCE